

# OFP401P0189

Color Sensor



Operating Instructions

## Table of contents

<b>1. Proper Use</b>	<b>4</b>
<b>2. Safety Precautions</b>	<b>4</b>
<b>3. EC Declaration of Conformity</b>	<b>4</b>
<b>4. Technical Data</b>	<b>5</b>
4.1. Connection Diagram	6
4.2. Housing dimensions	6
4.3. Control Panel	7
4.4. Complementary Products (see catalog)	7
<b>5. Mounting instructions</b>	<b>8</b>
<b>6. Initial Operation</b>	<b>8</b>
6.1. Initial Operation	8
6.2. Default Settings	9
<b>7. Functional description</b>	<b>10</b>
7.1. RUN	12
7.2. Pin function	12
7.3. E/A setting	13
7.3.1. Switching Output Assignment Teach-In	14
7.3.2. Switching Output Window Teach-In	15
7.3.3. Switching Output Sample Teach-In	15
7.3.4. Switching Output Tolerance	15
7.3.5. Tolerance H/S/L	16
7.3.6. Switching Output NPN/PNP	16
7.3.7. Switching Output NO/NC	16
7.3.8. Switching Output On-Delay	17
7.3.9. Switching Output Off-Delay	17
7.3.10. Switching Output Pulse Length	18
7.4. Display	18
7.4.1. Display Mode	18
7.4.2. Display Intensity	19
7.5. Assistant	19

7.6. Expert Menu	20
7.7. Operating mode	20
7.8. Filter	20
7.9. Emitted Light	21
7.10. E/A Test	21
7.10.1. Test Ax	21
7.11. Interface	22
7.12. Sensor type	22
7.14. Information	23
7.15. Reset	23
7.16. Password	23
<b>8. More Settings via the RS-232 Interface</b>	<b>24</b>

## 1. Proper Use

wenglor Color Sensors detect colors which have been previously defined. Surface color can be detected in scanning mode operation.

## 2. Safety Precautions

- This operating instruction is part of the product and must be kept during its entire service life.
- Read this operating instruction carefully before using the product.
- Installation, start-up and maintenance of this product has only to be carried out by trained personnel.
- Tampering with or modifying the product is not permissible.
- Protect the product against contamination during start-up.
- Not a safety component in accordance with the EU Machinery Directive.

## 3. EC Declaration of Conformity

The products are developed, constructed and manufactured according to the directive 2004/108/EC. The following international standards and specifications apply:

**EN 60947-5-2:2007**

Low-voltage switchgear and control gear, Part 5-2: Control circuit devices and switching elements – Proximity switches

Any additional standards which are applicable for the given application must be observed.



ME 61



**RoHS**

## 4. Technical Data

Order No.	OFP401P0189
Working Range	30...40 mm
Working Distance	35 mm
Light Source	White Light
Service Life (Tu = 25 °C)	100000 h
Max. Ambient Light	10000 Lux
Light Spot Diameter	3 mm
Supply Voltage	10...30 V
Current Consumption (Ub = 24 V)	< 80 mA
Switching Frequency	1.8 kHz
Response Time	300 $\mu$ s
Temperature Range	-25...60 °C
Switching Outputs	3
Switching Output Voltage Drop	1.5 V
PNP Switching Output/Switching Current	100 mA
Short Circuit Protection	yes
Reverse Polarity Protection	yes
Overload Protection	yes
Interface	RS-232
Digital Inputs	2
Protection Class	III
Adjustment	Teach-In
Housing	Plastic
Degree of Protection	IP68
Connection	M12 $\times$ 1; 8-pin
NO/NC switchable	✓
Configurable as PNP/NPN/Push-Pull	✓
RS-232 Interface	✓
Error Output	✓
Contamination Output	✓

## 4.1. Connection Diagram

OY1P303P0189

193

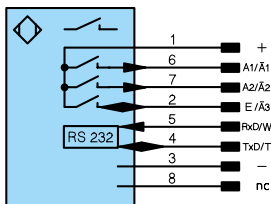

Legend

+	Supply Voltage +
-	Supply Voltage 0 V
~	Supply Voltage (AC Voltage)
A	Switching Output (NO)
A̅	Switching Output (NC)
V	Contamination/Error Output (NO)
V̅	Contamination/Error Output (NC)
E	Input (analog or digital)
T	Teach Input
Z	Time Delay (activation)
S	Shielding
RxD	Interface Receive Path
TxD	Interface Send Path
RDY	Ready
GND	Ground
CL	Clock
E/A	Output/Input programmable
	<b>IO-Link</b>
PoE	Power over Ethernet
IN	Safety Input
OSSD	Safety Output
Signal	Signal Output
nc	not connected

U	Test Input
U̅	Test Input inverted
W	Trigger Input
O	Analog Output
O-	Ground for the Analog Output
BZ	Block Discharge
Awv	Valve Output
a	Valve Control Output +
b	Valve Control Output 0 V
SY	Synchronization
E+	Receiver-Line
S+	Emitter-Line
≡	Grounding
S <sub>n</sub> R	Switching Distance Reduction
Rx+/-	Ethernet Receive Path
Tx+/-	Ethernet Send Path
B <sub>us</sub>	Interfaces-Bus A(+)/B(-)
La	Emitted Light disengageable
Mag	Magnet activation
RES	Input confirmation
EDM	Contactors Monitoring

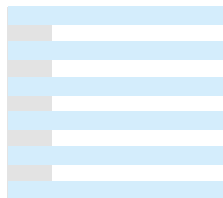

Wire Colors according to DIN IEC 757

BK	Black
BN	Brown
RD	Red
OG	Orange
YE	Yellow
GN	Green
BU	Blue
VT	Violet
GY	Grey
WH	White
PK	Pink
GNYE	Green Yellow

## 4.2. Housing dimensions

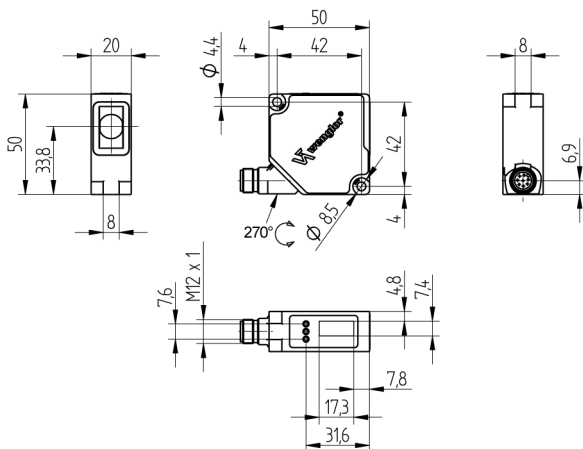

### 4.3. Control Panel

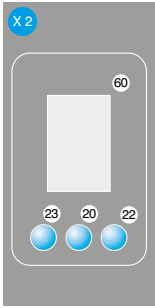

- 20 = Enter Button
- 22 = Up Button
- 23 = Down Button
- 60 = Display

### 4.4. Complementary Products (see catalog)

wenglor offers Connection Technology providing field wiring means.

Suiting Mounting Technology No.



Suiting Connection Technology No.



Interface Cable S232W3

Protection Housing Sets ZSP-NN-02

Protection Housing Sets ZSV-0x-01

## 5. Mounting instructions

During the operation of the Sensors, the corresponding electrical and mechanical regulations, as well as safety regulations must be observed. The Sensor must be protected from mechanical impact.

Mounting for glossy objects:

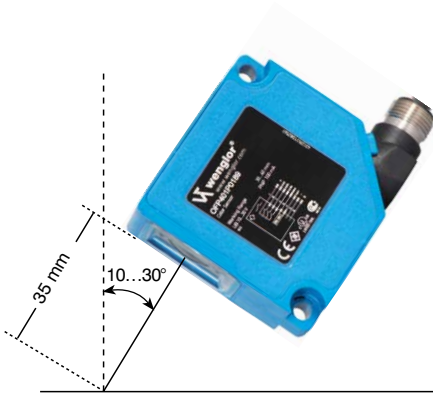

## 6. Initial Operation

### 6.1. Initial Operation

Connect the sensor to the supply voltage. After initialization the sensor shows the indication screen and is ready for operation. During the first commissioning and after a reset you can first of all select the menu language by simply pressing a button (see Fig. 1).



Fig. 1: Set menu language

The functions of the keys appear in the display as follows:

- ▲ : Navigate up.
- ▼ : Navigate down.
- ↵ : Selection is acknowledged with the enter key.

#### Meaning of the menu points:

- ▶ Next: One level down in the menu.
- ◀ Back: One level up in the menu.
- ◀◀ Run/Terminate: Change to the display mode:  
Change to the configuration menu by pressing any button.



**Notice:** If no setting is made in the configuration setting for a duration of 30 s, the sensor automatically jumps back into the display view.

By pressing the button once again, the sensor jumps back to the menu view used last. Settings made are adapted when quitting the configuration menu.

**Important:** Do not use pointed objects for sensor setting. Otherwise you risk damaging the buttons.

**Assistant:**

The sensor is equipped with an assistant for simplified adjustment to the respective application. After cancelling the configuration assistant, the complete menu appears at the display.

## 6.2. Default Settings

		OFP401P0189
<b>Pin function</b>	A1	Switching Output
	A2	Switching Output
	E/A3	Switching Output
	E4	Interface
<b>Outputs</b>	Teach mode	T Window
	Tolerance	Small
	Tolerance H	Small
	Tolerance S	Small
	Tolerance L	Small
	PNP/NPN/Push-pull	Push-pull
	NO/NC	NO
	On-Delay	0 ms
	Off-Delay	0 ms
Impulse	0 ms	
<b>Display</b>	Mode	Outputs
	Intensity	Screen saver
<b>Expert menu</b>		Off
<b>Operating Mode</b>		Detection
<b>Filter</b>		64
<b>Emitted light</b>		Medium
<b>Interface</b>	Baud rate	38400
<b>Type Select</b>		OFP
<b>Language</b>		English
<b>Password</b>	Activate	Off
	Change	0

## 7. Functional description

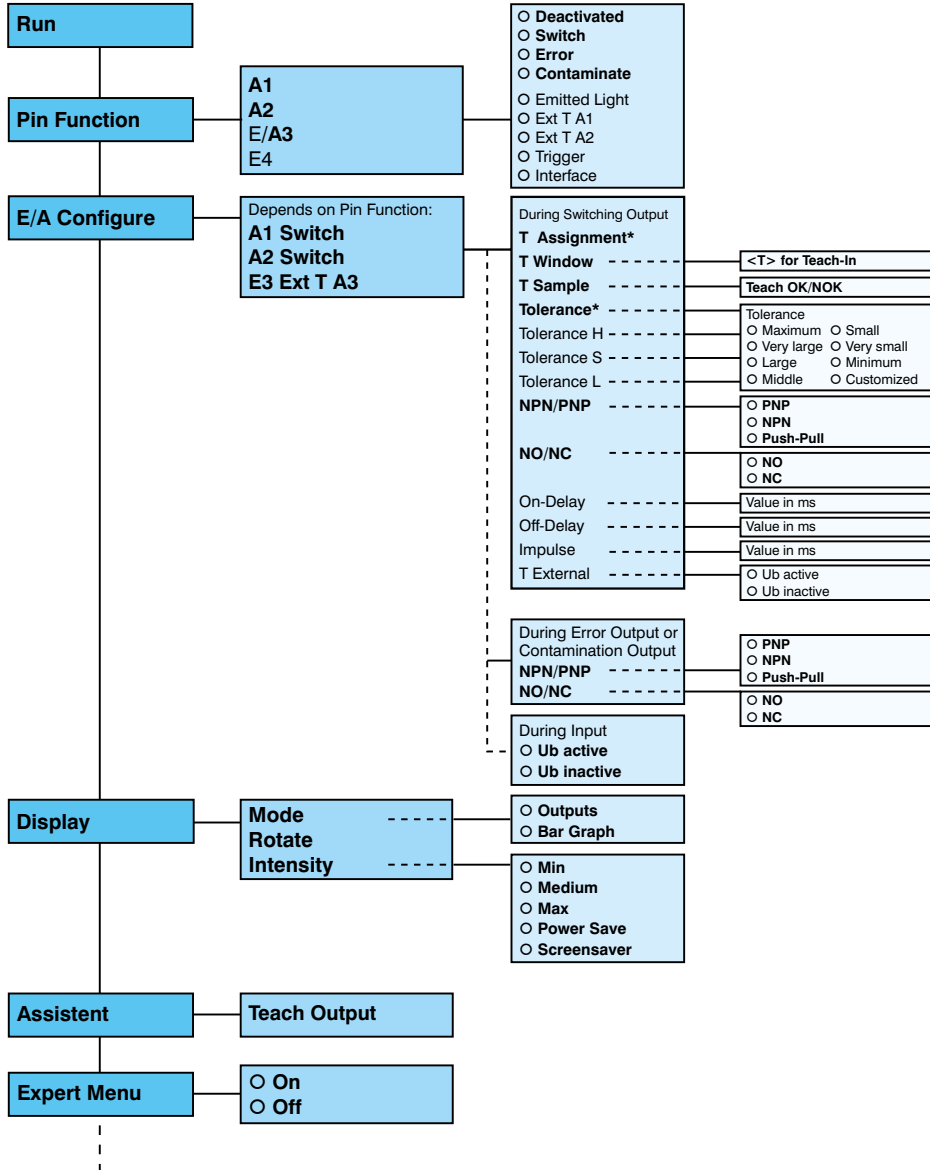

\* Visibility depends on the selected settings (details are provided in the corresponding chapter)

Menu items that are presented in **bold** are always displayed in the menu. The other menu items appear only when the Expert Menu is activated.

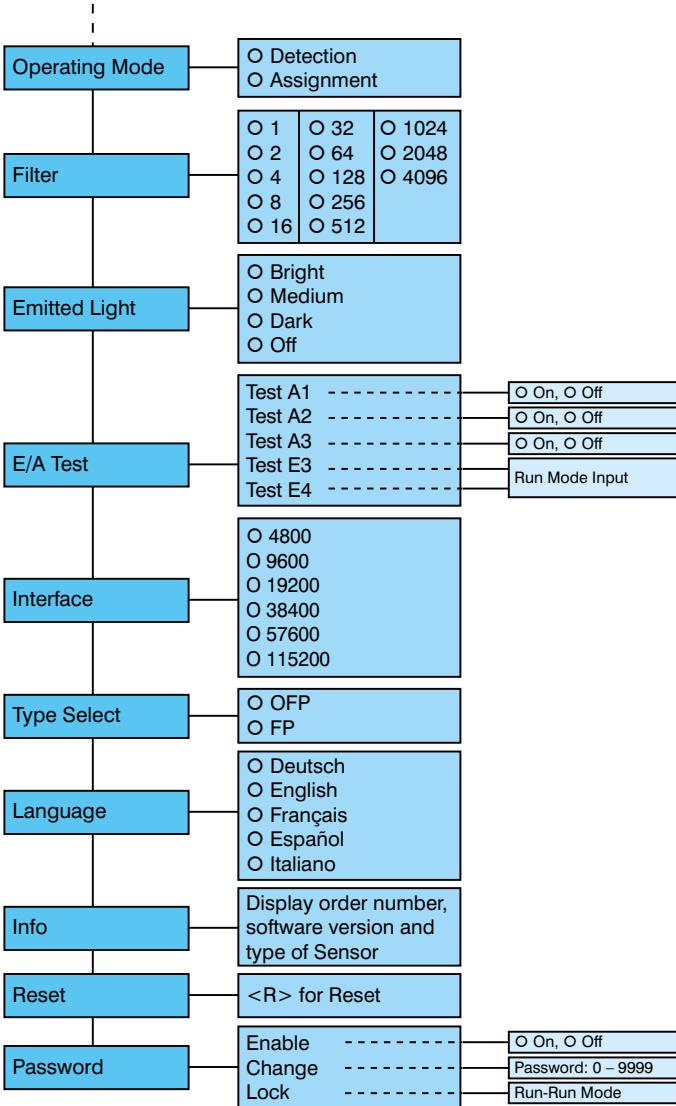

Below is an explanation of the functions of each menu item.

## 7.1. RUN

Sensor switches to display mode.

Set pin function E/A with corresponding condition. If E/A is not displayed, it is deactivated in the pin function menu item.



Meaning	Condition 1	Condition 2	Condition 3	Condition 4
Switching Output	🔌 Switched	⓪ Not switched	–	–
Error Output	✅ OK	⚠️ No signal	–	–
Contamination Output	✅ OK	☀️ Signal too low	–	–
Switch off emitted light	🔌 Emitted Light on	🔌 Emitted Light off	–	–
Teach-In Input	🔌 Active	⓪ Inactive	–	–
Trigger Input	🔌 Active	🔌 Inactive	–	–
Signal Strength	✅ OK	☀️ Signal too low	☀️ Signal too high	⚠️ No signal

## 7.2. Pin function

The Pin function is used to determine the function of pins A1, A2, E/A3 and/or E4 since the pins may be used for different functions.

<b>A1</b>	<b>Configuration of Pin A1</b>
<ul style="list-style-type: none"> <li>○ Deactivated</li> <li>○ Switch</li> <li>○ Error</li> <li>○ Contamination</li> <li>◀ Back</li> <li>◀◀ Run</li> </ul>	<p><b>Deactivated:</b> Deactivation of the output</p> <p><b>Switch:</b> Switching Output</p> <p><b>Error:</b> Error Output</p> <p><b>Contamination:</b> Contamination Output</p>
<b>A2</b>	<b>Configuration of pin A2</b>
<ul style="list-style-type: none"> <li>○ Deactivated</li> <li>○ Switch</li> <li>○ Error</li> <li>○ Contamination</li> <li>◀ Back</li> <li>◀◀ Run</li> </ul>	<p><b>Deactivated:</b> Deactivation of the output</p> <p><b>Switch:</b> Switching Output</p> <p><b>Error:</b> Error Output</p> <p><b>Contamination:</b> Contamination Output</p>

E/A3	Configuration of pin E/A2
<ul style="list-style-type: none"> <li>○ Deactivated</li> <li>○ Switch</li> <li>○ Error</li> <li>○ Contamination</li> <li>○ Emitted Light</li> <li>○ Ext T A1</li> <li>○ Ext T A2</li> <li>○ Trigger</li> <li>◀ Back</li> <li>◀◀ Run</li> </ul>	<p><b>Deactivated:</b> Deactivation of the output</p> <p><b>Switch:</b> Switching Output</p> <p><b>Error:</b> Error Output</p> <p><b>Contamination:</b> Contamination Output</p> <p><b>Emitted Light:</b> Input for switching on/off the emitted light</p> <p><b>Ext T A1:</b> Teach input for A1</p> <p><b>Ext T A2:</b> Teach input for A2</p> <p><b>Trigger:</b> Input for sensor triggering</p>
E4	Configuration of pin E4
<ul style="list-style-type: none"> <li>○ Interface</li> <li>○ Trigger</li> <li>◀ Back</li> <li>◀◀ Run</li> </ul>	<p><b>Interface:</b> Input for serial interface</p> <p><b>Trigger:</b> Input for sensor triggering</p>

### 7.3. E/A setting

Depending on the preset pin function, the name is displayed in this menu item, e.g. A1 Switch or e.g. E1 Laser. Each menu item includes the following sub items:

#### For Switching Output

If the pin is preset as Switching Output, the following functions may be set:

A1 Switch/A2 Switch	Sensor settings for switching outputs
<ul style="list-style-type: none"> <li>T Assignment</li> <li>T Window</li> <li>T Sample</li> <li>Tolerance</li> <li>Tolerance H</li> <li>Tolerance S</li> <li>Tolerance L</li> <li>NPN/PNP</li> <li>NO/NC</li> <li>On-Delay</li> <li>Off-Delay</li> <li>Impulse</li> <li>◀ Back</li> <li>◀◀ Run</li> </ul>	<p><b>T Assignment:</b> Teach-In of a color which is assigned to the output (only visible if "Assignment" operating mode is set)</p> <p><b>T Window:</b> Teach-In of a tolerance window in which the sensor is switched.</p> <p><b>T Sample:</b> Additional Teach-In of an OK or NOK sample</p> <p><b>Tolerance:</b> Specification of the color tolerance level **</p> <p><b>Tolerance H:</b> Specification of the color tolerance level "color value"*</p> <p><b>Tolerance S:</b> Specification of the color tolerance level "saturation value"*</p> <p><b>Tolerance L:</b> Specification of the color tolerance level "brightness value"*</p> <p><b>NPN/PNP:</b> Configuration of the output</p> <p><b>NO/NC:</b> Configuration of the output</p> <p><b>On-Delay:</b> On-Delay *</p> <p><b>Off-Delay:</b> Off-Delay *</p> <p><b>Impulses:</b> Impulse duration *</p> <p>* Only visible if the expert menu "on" is set. ** Only visible if the expert menu "off" is set.</p>

These menu items are described in more detail in chapter 7.3.1 to 7.3.10.

### For error and contamination output

If the pin is set as error or contamination output, the following functions can be set:

<b>A1 Error (example)</b>	<b>A1 and/or A2 as error output or contamination output</b>
NPN/PNP	<b>NPN/PNP:</b> Configuration of the output
NO/NC	<b>NO/NC:</b> Configuration of the output
◀ Back	
◀◀ Run	

Explanations for “NPN/PNP” are provided in chapter 7.3.6 on page 16. Explanations for “NO/NC” are provided in chapter 7.3.7 on page 16

### For emitted light switch-off input, external teach, trigger

If the pin is set as input for e.g. emitted light switch-off, it is possible to make a setting for input Ub active or Ub inactive:

<b>E3 Emitted Light (example)</b>	<b>Setting E3 and/or E4 input</b>
○ Ub active	<b>Ub active:</b> The input is activated if supply voltage (Ub) is applied.
○ Ub inactive	<b>Ub inactive:</b> The input is activated if no voltage is applied.
◀ Back	
◀◀ Run	

## 7.3.1. Switching Output Assignment Teach-In

**Notice:** The menu item is only visible if the expert menu is “on” and the operating mode is set to “Assignment”.



<b>T Assignment</b>	<b>Assignment Teach-In</b>
<T> for Teach-In	Teach-In Assignment-Teach-In process: 1) Adjust light spot to the object color 2) Press “T” button. -> The object color is taught in and allocated to the appropriate output.

### 7.3.2. Switching Output Window Teach-In

There are two switching points for window Teach-In. The size of the window is referred to as tolerance. If a color is within the window, the sensor switches.

T Window	Window Teach-In
<T> for Teach-In	<p>Teach-In Window-Teaching process:</p> <ol style="list-style-type: none"> <li>1) Align illuminated spot with the background (if available) or to the object.</li> <li>2) Press “T” button. -&gt; The switching points are taught in.</li> </ol> <p><b>Notice:</b></p> <ul style="list-style-type: none"> <li>• T Sample: Additional Teach-In of OK or NOK samples in order to adjust tolerance.</li> <li>• In the “Tolerance” menu item (see chapter 7.3.4), the size of the window width can be reduced or increased.</li> </ul>

### 7.3.3. Switching Output Sample Teach-In

T Sample	Sample Teach-In			
Teach OK/NOK	<table border="1" style="width: 100%; border-collapse: collapse;"> <tr> <td style="background-color: black; color: yellow; text-align: center; width: 100px;">OK</td> <td rowspan="2"> <p>Teach-In Sample Teaching process:</p> <ol style="list-style-type: none"> <li>1) Teach-In of OK sample               <ul style="list-style-type: none"> <li>• Align light spot with the object.</li> <li>• Press “OK” button. -&gt; Tolerance is increased.</li> </ul> </li> <li>2) Teach-In of NOK sample               <ul style="list-style-type: none"> <li>• Align light spot with the object.</li> <li>• Press “NOK” button. -&gt; Tolerance is decreased.</li> </ul> </li> </ol> </td> </tr> <tr> <td style="background-color: black; color: yellow; text-align: center;">             NOK         </td> </tr> </table>	OK	<p>Teach-In Sample Teaching process:</p> <ol style="list-style-type: none"> <li>1) Teach-In of OK sample               <ul style="list-style-type: none"> <li>• Align light spot with the object.</li> <li>• Press “OK” button. -&gt; Tolerance is increased.</li> </ul> </li> <li>2) Teach-In of NOK sample               <ul style="list-style-type: none"> <li>• Align light spot with the object.</li> <li>• Press “NOK” button. -&gt; Tolerance is decreased.</li> </ul> </li> </ol>	 NOK
OK	<p>Teach-In Sample Teaching process:</p> <ol style="list-style-type: none"> <li>1) Teach-In of OK sample               <ul style="list-style-type: none"> <li>• Align light spot with the object.</li> <li>• Press “OK” button. -&gt; Tolerance is increased.</li> </ul> </li> <li>2) Teach-In of NOK sample               <ul style="list-style-type: none"> <li>• Align light spot with the object.</li> <li>• Press “NOK” button. -&gt; Tolerance is decreased.</li> </ul> </li> </ol>			
 NOK				

### 7.3.4. Switching Output Tolerance

**Notice:** The menu item is only visible if the expert menu is set to “off”.

Tolerance	Changing tolerance
○ Maximum	<b>Maximum:</b> Tolerance is set to a maximum value.
○ Very large	<b>Very large:</b> Tolerance is set to a very large value.
○ Large	<b>Large:</b> Tolerance is set to a large value.
○ Middle	<b>Middle:</b> Tolerance is set to a medium value.
○ Small	<b>Small:</b> Tolerance is set to a small value.
○ Very small	<b>Very small:</b> Tolerance is set to a very small value.
○ Minimum	<b>Minimum:</b> Tolerance is set to a minimum value.

### 7.3.5. Tolerance H/S/L

The menu item is only visible if the expert menu is “on” and the operating mode is set to “Detection”.

Tolerance	Changing tolerance	
<ul style="list-style-type: none"> <li>○ Maximum</li> <li>○ Very large</li> <li>○ Large</li> <li>○ Middle</li> <li>○ Small</li> <li>○ Very small</li> <li>○ Minimum</li> <li>○ Customized</li> </ul>	<b>Maximal:</b>	Tolerance is set to a maximum value.
	<b>Very large:</b>	Tolerance is set to a very large value.
	<b>Large:</b>	Tolerance is set to a large value.
	<b>Middle:</b>	Tolerance is set to a medium value.
	<b>Small:</b>	Tolerance is set to a small value.
	<b>Very small:</b>	Tolerance is set to a very small value.
	<b>Minimum:</b>	Tolerance is set to a minimum value.
	<b>Customized:</b>	By pressing the “+”, tolerance can be increased. By pressing the “-”, tolerance can be decreased. Keep the button pressed to achieve larger jumps in value.

### 7.3.6. Switching Output NPN/PNP

NPN/PNP	Output configuration	
<ul style="list-style-type: none"> <li>○ PNP</li> <li>○ NPN</li> <li>○ Push-pull</li> <li>◀ Back</li> <li>◀◀ Run</li> </ul>	<b>PNP:</b>	A load or the evaluation device is connected between the negative pole (supply) and the output. If switched, the output is connected with the positive pole via an electric switch.
	<b>NPN:</b>	A load or the evaluation device is connected between the positive pole (supply) and the output. If the sensor switches, the output is connected with the negative pole via an electric switch.
	<b>Push-pull:</b>	Push-pull output. Acts like an electronic switch which optionally switches the output to the positive pole or the negative pole.

### 7.3.7. Switching Output NO/NC

NO/NC	Output configuration	
<ul style="list-style-type: none"> <li>○ NO</li> <li>○ NC</li> <li>◀ Back</li> <li>◀◀ Run</li> </ul>	<b>NO:</b>	Normally open. The output closes as soon as an object reaches the switching point.
	<b>NC:</b>	Normally closed. The output opens as soon as an object reaches the switching point.



### 7.3.8. Switching Output On-Delay

The On-Delay is an adjustable extension of the response time.

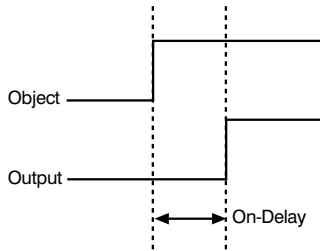

**Notice:** The menu item is only visible if the expert menu is set to “on”

On-Delay	Setting of On-Delay
<i>On-Delay in ms</i>	By pressing the “+” or “-” button, a On-Delay from 0 ms to 10000 ms can be set. Keep the button pressed to achieve larger jumps in value.

### 7.3.9. Switching Output Off-Delay

The Off-Delay is an adjustable extension of the drop-out time.

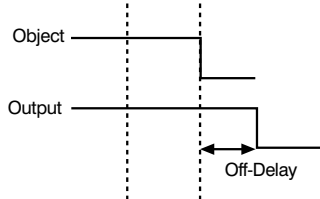

**Notice:** The menu item is only visible if the expert menu is set to “on”

Off-Delay	Setting of Off-Delay
<i>Off-Delay in ms</i>	By pressing the “+” or “-” button, a Off-Delay from 0 ms to 10000 ms can be set. Keep the button pressed to achieve larger jumps in value.

**Notice:** If an impulse length has been set, no Off-Delay can be set. In this case, the notice “Impulse” will appear in the control panel!

### 7.3.10. Switching Output Pulse Length

The pulse length defines how long the switching state is held. The function can be combined with a response time delay.

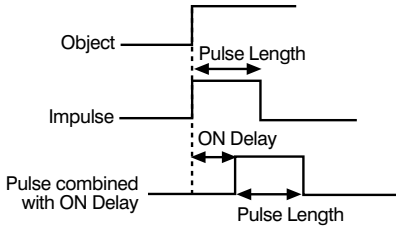

**Note:** The menu item is only visible if Expert Menu “On” has been set.

<b>Impulse</b>	<b>Set pulse length</b>
<i>Pulse length in ms</i>	A pulse length of 0 to 10000 ms can be set by pressing the “+” key or the “-” key. You can keep a key pressed for a longer time in order to make larger numerical jumps.

## 7.4. Display

<b>Display</b>	<b>Adjusting the display device</b>
Mode	<b>Mode:</b> Select display mode (see chapter 7.4.1)
Rotate	<b>Rotate:</b> Rotate display by 180°. The display is rotated by 180° by pressing the ↵ key. The rotation is canceled by pressing this key again.
Intensity	<b>Intensity:</b> Set the display intensity (see chapter 7.4.2)
◀ Back	
⏪ Run	

### 7.4.1. Display Mode

<b>Mode</b>	<b>Select display mode</b>
○ Outputs	<b>Outputs:</b> The condition of each output is indicated on the display.
○ Bar Graph	<b>Bar Graph:</b> The RGB color spaces / shares of the object are indicated in a bar graph.
◀ Back	
⏪ Run	

## 7.4.2. Display Intensity

Intensity	Set the display intensity
<input type="radio"/> Min <input type="radio"/> Normal <input type="radio"/> Max <input type="radio"/> Power save <input type="radio"/> Screen saver ◀ Back ⏪ Run	<p><b>Min:</b> The intensity of the display is set to a minimum value.</p> <p><b>Medium:</b> The intensity of the display is set to a normal value.</p> <p><b>Max:</b> The intensity of the display is set to a maximum value.</p> <p><b>Power save:</b> The display switches off after one minute without a button being pressed and automatically switches back on when a button is pressed.</p> <p><b>Screen saver:</b> The colors of the display are inverted every minute.</p>

## 7.5. Assistant

Assistant	Starting/using the assistant
<input type="radio"/> Output Teach-In ▶ Next ◀ Back ⏪ Run	The sensor is equipped with an assistant for the simplified setting to each application. If you abort the configuration assistant, you will return to the comprehensive menu.

If you use the assistant, you will get the following support for teaching in object colors:

Select output <input type="radio"/> A1 <input type="radio"/> A2 <input type="radio"/> A3 ▶ Next ◀ Back ⏪ Exit	<p>Here you can select the output for which a color should be taught in.</p> <p>Acknowledge your selection always with ▶ Next in order to access the next window.</p>
Aligning light spot with the color <input type="radio"/> Teach-In (T) ▶ Next ◀ Back ⏪ Exit	Align your object with the working area and select Teach-In (T). You will get a message whether Teach-In was successful.
Does the sensor switch reliably? <Ax Display> <input type="radio"/> Yes <input type="radio"/> T Sample OK <input type="radio"/> T Sample NOK <input type="radio"/> No ▶ Next ◀ Back ⏪ Exit	<p>Select &lt;Ax Display&gt; in order to check in the OLED display whether each taught-in output reliably switches to the taught-in color. If the output does not switch reliably, you have the following options:</p> <ul style="list-style-type: none"> <li>• T Sample OK: You may teach in another OK sample. This increases the tolerance.</li> <li>• T Sample NOK: You may teach in a NOK sample. This decreases the tolerance.</li> <li>• No: You may completely re-Teach-In the color.</li> </ul>
Want to teach in another output? <input type="radio"/> Yes <input type="radio"/> No ▶ Next ◀ Back ⏪ Exit	Select "Yes" to teach in another color on another output. Select "No" to quit the assistant.

## 7.6. Expert Menu

Depending on whether the expert menu is “on” or “off”, different menu items and sub-items appear in the menu. The expert menu is disabled in the default settings. Thus, the menu is shorter and easier to use. If the available menu items are not sufficient for the application solution, the expert menu can be enabled and the entire scope of sensor functions can be used.

Expert Menu	Enable or disable expert menu
<input type="radio"/> On <input type="radio"/> Off ◀ Back ◀◀ Run	<p><b>On:</b> The expert menu is disabled and only a few menu items are displayed.</p> <p><b>Off:</b> The expert menu is enabled and all menu items are displayed.</p>

## 7.7. Operating mode

**Notice:** The menu item is only visible if the expert menu is set to “on”.

Operating mode	Select operating mode
<input type="radio"/> Detection <input type="radio"/> Assignment ◀ Back ◀◀ Run	<p><b>Detection:</b> In the “Detection” operating mode, color windows are taught in to an output. The sensor detects the taught-in colors within a certain range if they are within the tolerance (see chapter 7.3.4/7.3.5).</p> <p><b>Assignment:</b> In the “Assignment” operating mode, one color each can be taught in and assigned to the outputs. The sensor evaluates the current color value and assigns it to the most similar color of the corresponding output. Thus, one of the outputs is always enabled in this operating mode. Thus, the reliable assignment of all object colors is possible.</p>

## 7.8. Filter

**Note:** The menu item is only visible if Expert Menu “On” has been set.

Filter	Number of values for averaging.
<input type="radio"/> 4 <input type="radio"/> 8 <input type="radio"/> 16 <input type="radio"/> 32 <input type="radio"/> 64 <input type="radio"/> 128 <input type="radio"/> 256 <input type="radio"/> 512 <input type="radio"/> 1024 <input type="radio"/> 2048 <input type="radio"/> 4096 ◀ Back ◀◀ Run	<p>The filter (filter size) is the number of measured values the sensor uses for averaging. The larger the filter, the slower the response time of the sensor.</p>

## 7.9. Emitted Light

In the “Emitted Light” menu item, the intensity of the emitted light can be modified or the emitted light can be switched off.

**Notice:** The menu item is only visible if the expert menu is set to “on”.

Emitted Light	Set emitted light
<ul style="list-style-type: none"> <li>○ High</li> <li>○ Medium</li> <li>○ Low</li> <li>○ Off</li> <li>◀ Back</li> <li>◀◀ Run</li> </ul>	<p><b>High:</b> The intensity of the emitted light is set to “bright”. Due to the increased signal strength, dark objects with low remission are more easily detected.</p> <p><b>Medium:</b> The intensity of the emitted light is set to “normal”.</p> <p><b>Low:</b> The intensity of the emitted light is set to “dark”. Due to the reduced signal strength, the color value of very bright objects is more easily detected.</p> <p><b>Off:</b> The own emitted light is switched off, and only the extraneous light is evaluated. Thus, even luminous objects can be detected.</p>

## 7.10. E/A Test

This function manually changes the outputs, independently of the actual measurement value of the Sensor. In that way it is possible to check, for example, whether the outputs are properly connected to a controller or whether there is a fault on the cable that modifies the output value. It can likewise be tested whether a voltage is arriving at an input pin.

The test is automatically terminated when you leave the test menu.

**Note:** The menu item is only visible if Expert Menu “On” has been set. Only the functions for which the pin is set are displayed in each case.

E/A Test	E/A Test of the inputs and outputs
<ul style="list-style-type: none"> <li>Test A1</li> <li>Test A2</li> <li>Test A3</li> <li>Test E3</li> <li>Test E4</li> <li>◀ Back</li> <li>◀◀ Run</li> </ul>	<p>Test A1: Test output 1 (see chapter 7.10.1)</p> <p>Test A2: Test output 2 (see chapter 7.10.1)</p> <p>Test A3: Test output 3 (see chapter 7.10.1)</p> <p>Test E3: Display whether 0 V or 24 V is present at input 3</p> <p>Test E4: Display whether 0 V or 24 V is present at input 4</p>

### 7.10.1. Test Ax

Test Ax	Switch outputs on or off
<ul style="list-style-type: none"> <li>○ On</li> <li>○ Off</li> <li>◀ Back</li> <li>◀◀ Run</li> </ul>	<p>On: Switch output on (24 V)</p> <p>Off: Switch output off (0 V)</p>

## 7.11. Interface

**Note:** The menu item is only visible if the expert menu is set to “on”.

Baud rate	Setting the baud rate
<input type="radio"/> 4800	<b>4800:</b> 4800 baud
<input type="radio"/> 9600	<b>9600:</b> 9600 baud
<input type="radio"/> 19200	<b>19200:</b> 19200 baud
<input type="radio"/> 38400	<b>38400:</b> 38400 baud (standard setting)
<input type="radio"/> 57600	<b>57600:</b> 57600 baud
<input type="radio"/> 115200	<b>115200:</b> 115200 baud
◀ Back	
◀◀ Run	

## 7.12. Sensor type

**Notice:** The menu item is only visible if the expert menu is set to “on”.

Type Select	Set type select
<input type="radio"/> OFP	<b>OFP:</b> All described menu items are enabled and the interface is issued according to the OFP interface protocol.
<input type="radio"/> FP	<b>FP:</b> The sensor is compatible to the predecessor product FP04PCT80.
◀ Back	
◀◀ Run	

## 7.13. Language

The menu language can be changed in the menu item “Language”. The user is automatically prompted for his desired language at initial operation and after each reset.

The menu item is only visible if the expert menu is set to “on”.

Language	Set menu language
<input type="radio"/> Deutsch	The menu appears in the selected language immediately after selection.
<input type="radio"/> English	
<input type="radio"/> Français	
<input type="radio"/> Español	
<input type="radio"/> Italiano	
◀ Back	
◀◀ Run	

## 7.14. Information

**Note:** The menu item is only visible if Expert Menu “On” has been set.

The following information about the Sensor is displayed in the “Info” menu item.

<b>Info</b>	
<i>Order number</i> <i>Software version</i> <i>Type Select</i> ◀ Back ◀◀ Run	

## 7.15. Reset

The Sensor setting can be reset to the delivery state in the menu item “Reset”. The settings in the delivery state can be found in chapter “6.2. Default Settings” on page 9.

The menu item is only visible if the expert menu is set to “on”.

<b>Reset</b>	<b>Set back to the delivery state</b>
<R> for Reset	The Sensor settings that have been made can be reset to the delivery state by pressing the “R” key.

## 7.16. Password

Password protection prevents against unintended changing of the set data.

The menu item is only visible if the expert menu is set to “on”.

<b>Password</b>	<b>Set password functionality</b>
Activate Change Lock ◀ Back ◀◀ Run	<b>Activate:</b> Turn password protection on or off. If password protection is activated, the operation of the Sensor is disabled after supply power has been interrupted and is only enabled after successful password input. <b>Change:</b> Change password. <b>Lock</b> Locking Sensor causes an immediate disabling of operation if activate Password is set to “On”.

If the password function has been activated, the password must be entered each time supply power to the Sensor is interrupted. After entering the correct password with the + or – key, the entire menu is enabled and the Sensor is ready for use.

- The password function is deactivated upon shipment from the factory.
- Passwords can be selected within a range of 0000 to 9999.

Be sure to make a note of the new password before exiting the “change password” function! If the password is forgotten, it must be overwritten with a master password. The master password can be requested by e-mail from [support@wenglor.com](mailto:support@wenglor.com).

## 8. More Settings via the RS-232 Interface

The interface makes use of the software handshake procedure. All settings can be configured at a PC and uploaded to the device. RS-232 interface connections RxD (5) and TxD (4) are linked to minus (pin 3), and can be connected to the corresponding terminals at the communication partner.

### Interface configuration:

Adjustable baud rate, 8 data bits, no parity, 1 stop bit

Connect the Sensor via wenglor interface cable S232W3 to the PC or controller as follows

- Disconnect 8-pin interface cable ZAS89xxx from the Sensor
- Plug interface cable S232W3 directly into the Sensor
- Plug 8-pin connection cable ZAS89xxx directly into the interface cable
- Connect 9-pin SUB-D plug of the S232W3 into the serial port of the PC or controller
- Switch on power supply

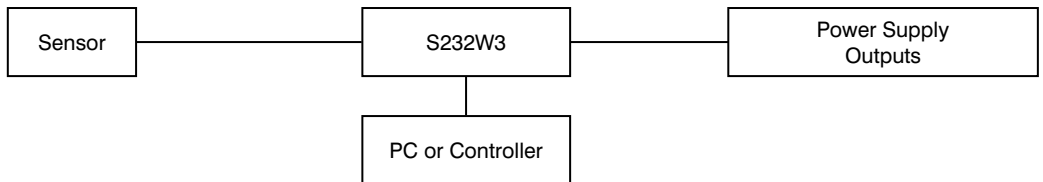

You can download the OFF interface protocol as PDF document from our homepage [www.wenglor.com](http://www.wenglor.com) in the **Download** link.

## 9. Maintenance Instructions

- This wenglor Sensor is maintenance-free.
- It is advisable to clean the lens and the display, and to check the plug connections at regular intervals.
- Do not clean with solvents or cleansers which could damage the device.

## 10. Proper Disposal

wenglor sensoric gmbh does not accept the return of unusable or irreparable products. Respectively valid national waste disposal regulations apply to product disposal.